



**DELUXE**

# *Baby Hammock & Stand Pack*

Congratulations on choosing the ideal first bed for your baby! We appreciate the confidence you have expressed in the Natures Sway® brand through your purchase. Natures Sway has endeavoured to create a reliable, safe, and durable product by using carefully sourced, high quality components. All of our products are covered by warranty.

Please take the time to read of all the information in this booklet. It's important to ensure correct assembly so that your baby will enjoy the maximum benefits that sleeping in a hammock can bring. We ask that you trust your instincts as a parent to keep your baby safe.

If you are in any doubt about the correct use of this product, please consult the safety check-list overleaf or contact us.

- Naturally soothes baby with its gentle bounce and cocoon-like design.
- Free from chemical dyes or bleach.
- Made from double boiled, pre-washed cotton calico or 55% hemp, 45% certified organic cotton (Organics option).
- Pure New Zealand wool mattress.
- Keeps baby safely on their back with even, continuous support for their spine.



**+ Door Clamp,  
Chain & Screws**

est.  
**1993**  
AUTHENTIC &  
ORIGINAL

*"The natural way to  
welcome your newborn"*

**NEW  
ZEALAND  
MADE**

## ***Safe Use:***

- This hammock is exclusively intended for back sleeping only. Do not place baby on their side or tummy.
- The weight limit for this hammock is 15kg. For an infant of 10kg or more we recommend using 2 springs side by side for a firmer bounce.
- The hammock should never be bounced so hard as to cause the parts to 'jump'.
- Never use with a mattress wider than 35cm, longer than 100cm or thicker than 2.5cm when compressed. Warning: do not modify base with a flat board. If a firmer base is preferred please use our cocofibre mattress stiffener and only for babies 4kg or heavier.
- The hammock base must be no higher than 40cm above the ground, with the exception from 0-2 months when you may find that having the hammock at waist height is safer and easier on your back.
- Do not sleep baby in excessive layers of bedding or clothing and avoid synthetic materials as babies can overheat. Note: Hats are not suitable as they can move over the face and interfere with breathing.
- As per bassinet standards: When a child is able to roll, sit, kneel or to pull itself up, the hammock is no longer safe and should not be used.**

## ***Safety Check:*** *Please ensure hammock is assembled correctly.*

- Check your choice of suspension option is secure. See stand safety check list on page 7 and the ceiling and door clamp information on pages 4-5.
- Check the hammock is centred and fixed at the top ring with either our recommended D-ring or with a secure tie.
- Always ensure the wooden beam is securely fastened to the hammock body and is horizontal to within 5°.
- Check that all clips and hooks are closed and secure. NEVER use the hammock with open hooks as bouncing may cause disconnection between parts.
- Do not use hammock if parts are broken, torn, frayed or missing.
- Do not suspend the hammock from any fixture not recommended by Natures Sway.

## ***Safe Environment:***

- Check the floor area under the hammock is free of obstacles.
- Ensure that any ties or mobiles are well out of reach of small children.
- Keep your baby and the hammock close by, for instance in the living room for day sleeps and by the caregivers bed for night sleeping.
- Never leave young children unsupervised in the vicinity of the hammock. It is not intended as a swing or as children's play equipment.
- Pay close attention to your baby's surroundings and environment. Do not place the hammock next to any open fire, wood stove, gas heater, electric heater, heat pump or other source of strong heat.

# Natures Sway Deluxe Hammock & Stand Pack:

- Natures Sway Hammock**  
 Includes: pre-washed hammock body, wooden beam, galvanised spring (with safety strap, cover and stainless steel swivel snap hook), stainless steel D-ring and a carry bag for your hammock.
- Natures Sway Stand**  
 Includes: 8 leg pieces with locking pins (4 connecting & 4 foot poles), top section requiring assembly (2 u-bar tubes, 2 washers, 8mm coach-eye bolt with nylock nut, black plastic spacer, tri-lock plastic knob & Hammock Stand Top Assembly Instructions). Packed in a re-usable carry box.
- Natural Wool Mattress**
- 2 Cotton Fitted Sheets**
- Chain & Screws**
- Door Clamp**
- Instruction Booklet**

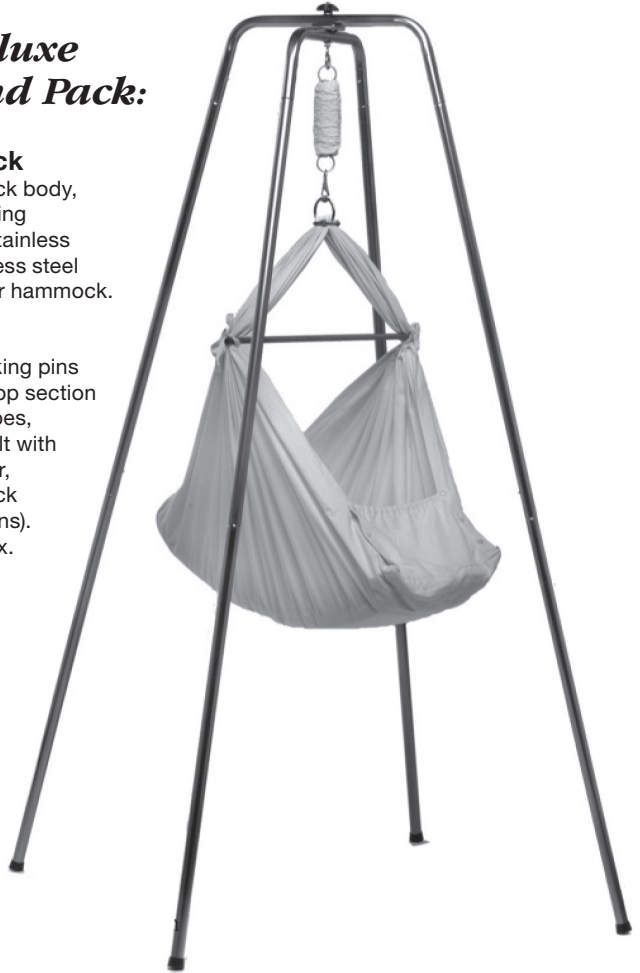

**PLEASE READ AND FOLLOW THESE INSTRUCTIONS BEFORE USING THE PRODUCT. RETAIN FOR FUTURE USE.**

# Suspension Options:

*With 3 suspension options you can take your hammock anywhere!*

## 1 Ceiling Attachments

Where at all possible we recommend hanging your hammock from the ceiling. This option saves space and gives best access and height flexibility. For example, you can hang the hammock next to or even over your bed.

### Natures Sway Ceiling Screws Pack

Our carefully selected stainless steel coach-eye screws are designed for suspension from a wooden beam or ceiling joist. Note: these are for solid wood only. Do not use alternative hooks which are open, you need the closed loop of the coach-eye for safety.



### Natures Sway Chain & Karabiner Set

The stainless steel chain with karabiner at each end is available in 1/2m or 1m lengths and are designed for attaching the hammock to a ceiling screw or door clamp where doorways or arches are particularly high. You can also use the chain to wrap around an exposed beam or branch. Secure both ends with the karabiners then attach spring and hammock.



## Installation

To select a site for hanging the baby hammock, look for a draught free area with a sturdy wooden beam or ceiling joist in the ceiling close to your bed or living area. You may need to use a stud finder or consult a building professional.

Drill a small pilot hole of no more than 4mm diameter and 40mm deep into the center of the beam. Screw the ceiling screw fully into the hole so that at least 40mm of the screw is able to grip into solid wood. For a home test, make sure the screw can hold an adults weight once it is installed.

Only then should it be used for your baby.

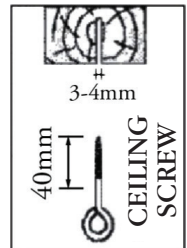

*“Natures Sway baby hammocks provide our newborn infants with a natural alternative to sleeping ‘in mother’. At Birthcare we have been delighted with the success that settling in a hammock can bring. Hammocks are available in most private rooms and, of course, in the nursery.”*

Birthcare, Auckland, New Zealand

## 2 Door Clamp

For a great mobile or temporary option, the Natures Sway Door Clamp is sometimes the best solution as when traveling it will often fit on the frame of an open wardrobe. If visiting a friend you can take baby's familiar bed for their routine sleep without needing to transport the stand. The powder-coated door clamp is designed to clamp onto the framing of most standard doorways up to 250mm wide and is sprung loaded to grip tighter the more weight you apply. It has clear non-toxic PVC tubing on the top clamps to protect paintwork and provide a non-slip hold, and a stainless steel quick-link for secure and easy hammock attachment.

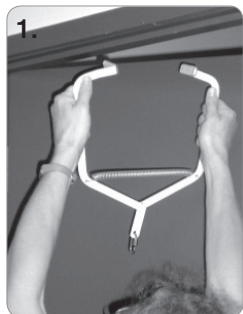

Open door clamp.

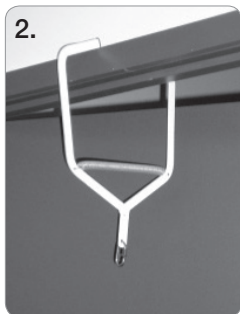

Hook over framing and pull down to check it is secure.



Attach hammock spring with the quick-link clip.

### Important Safety Information:

- Do not use if the framing is worn, broken or damaged.
- Do not use if the top of the door framing is sloped or curved.
- Ensure quick-link clip is closed – finger tight only.
- Only suitable for babies up to 20kg.
- Do not swing from door clamp.

*“We felt it a good omen when the hammock arrived, it was so beautiful and obviously made with great love and attention to detail.”*

Nancy Goodstein



### 3 Natures Sway Hammock Stand

Your purchase of the Natures Sway Hammock Stand offers you more options for portability and convenience than fixed ceiling suspension. In our search for the ideal alternative to ceiling suspension we considered and tested many different hammock stand prototypes, but we have concluded that the four legged U-bar option is the safest, tallest and most stable design. There are no dangerous bars directly underneath the hammock and it cannot be swung or tipped, the primary motion is bouncing up and down on the spring.

The stand is ideal if you want the freedom of moving the hammock anywhere both indoors and outdoors. At 188cm tall it takes up less than 1m<sup>2</sup> of floor space. It's easy to assemble and dismantle. It packs down to under 1m long and less than 7kg for storage and portability.

The stand is manufactured in New Zealand from strong lightweight tubular steel and is powder-coated either silver-gray for a cool metallic finish or desert-sand for a warm beige tone.

#### *Setting Up Your Hammock Stand*

1. Follow the **Hammock Stand Top Assembly Instructions** (included in top section parts bag) to assemble top section. Turn the top U-bar a quarter turn so that it sits in the top groove of the spacer.
2. Tighten the tri-lock nut to secure – do not over tighten.

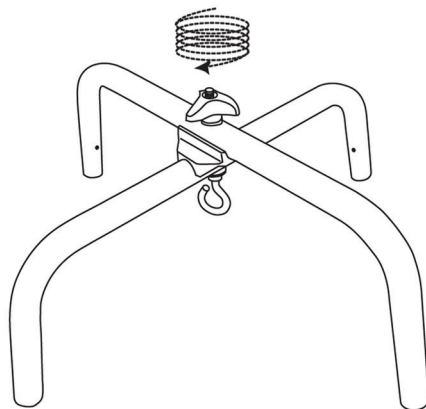
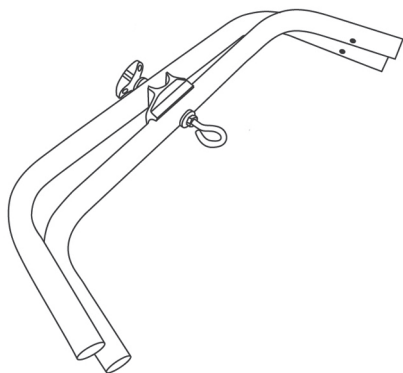

### Stand Safety Check:

- Always make sure the coach-eye bolt and tri-lock are finger tight before use. Do not over tighten the tri-lock knob.
- Check all locking pins are fully engaged.
- Ensure the hammock stand is on a flat even surface and kept clear of hard objects.
- Stand weight limit is **25kg**.
- Do not allow the hammock to be used as a toy. Under no circumstances is it to be used as a swing.
- Do not leave the stand outside overnight or in the rain.
- Do not use the hammock stand or hammock if any parts are broken, damaged or missing.
- Use of any other items with this stand voids the responsibility of Natures Sway.



3. Attach the U-bar frame to the connecting poles then connect the foot poles. Ensure all locking pins are fully engaged in holes.

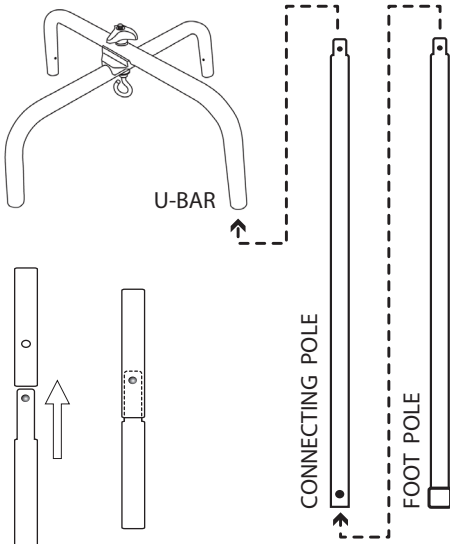

4. Attach the spring to the coach-eye bolt on the stand by tilting the spring 45° so it fits in the purpose made 5mm gap in the bolt.

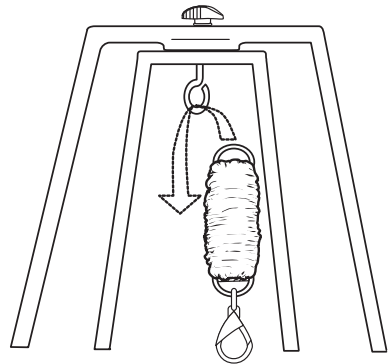

# Setting Up Your Baby Hammock

1. Attach the end of the spring either to the chain and karabiner clip hanging from the ceiling, the quick-link at the bottom of the door clamp or the coach-eye of the stand. The swivel snap hook on the bottom of the spring should be hanging between 130-150cm from the ground i.e. about head height when hanging from ceiling.
2. Attach the stainless steel ring on the hammock body to the swivel snap hook. Ensure that the D-ring sitting just below the ring is closed and is holding the fabric so the hammock is exactly centred. If you fold the hammock in half the sides should be even. This fitting has been included to stabilise the hammock and prevent side tilting. Contact us if you have an earlier model with a fabric tie or no D-ring.
3. You will find cotton ties on each side of the hammock, 36cm down from the top, the wooden spreader beam is designed to sit just above these points. Tightly gather and bunch the fabric until it can be squeezed into the notches at the ends of the beam. Do both sides and check the beam is horizontal. To secure it in place, wrap the cotton ties once around the fabric below the beam, then cross up over the wood and tie with a bow.



4. Customer needs to wash and dry the fitted sheet before making the bed. All other parts are ready for use once assembled.

If a mattress protector is desired, please use a breathable one such as wool or the Natures Sway Mattress Protector – do not use plastic.



***“Our positive identity is based on feeling right, good and welcome...”***

From the Continuum Concept by Jean Leidloff – an inspiration to Natures Sway.



## *Placing Your Baby in the Hammock*

1. Place your baby on their back in the centre of the hammock. A newborns head can be proportionately heavier than their body, sometimes causing the head to tilt lower than the feet in the hammock. If this happens, simply place a small weight under the mattress at the foot-end to elevate the head-end. This can also be a good position for babies prone to reflux.
2. A key feature of the hammock is that it makes babies feel held so expect it to fold gently around your baby. This is perfectly safe for babies lying on their back, even when they turn their head, as the wool will naturally compact rather than push against them (unlike foam).
3. Some parents prefer a slightly firmer base for their baby. The Natures Sway Coco-fibre Mattress Stiffener, placed under the mattress, assists in keeping the sides open around baby. If it is the curve that you wish to reduce then place a small folded towel under the mattress and/or stiffener from the shoulder area down. This will ensure the head is tilted back slightly and the airway is clear. Exercise caution, it's possible a very light newborn could roll if the mattress is too firm, so NEVER make the base rigid or completely flat. We recommend using the Coco-fibre Mattress Stiffener for babies 4kg or heavier.
4. The gentle curve of the hammock keeps babies on their back and is designed to support the natural C-curve of their developing spine and nervous system. Babies spines and hips are not ready for load bearing until they start to walk, the fabric of the hammocks offers even, continuous support and reduces pressure points especially on the head, shoulders and hips.
5. A soft sheet or blanket can be placed up to baby's shoulders and tucked into the sides for extra warmth. Alternatively a baby swaddle, wrap or purpose built sleeping bag are great options. The wool mattress will keep baby quite warm so keep extra bedding to a minimum.
6. Babies use the hammock (on average) for their first 6 months. Around this stage they naturally require less bouncing to soothe them, their bodies are beginning to straighten and strengthen and a still, flat bed becomes the bed of choice.
7. Most babies will transfer from their hammocks quite naturally and easily any time from 3 to 12 months, depending on their temperament and needs. For babies who still like to sleep in the hammock past 9 months we have longer accessories.

**If baby begins to roll, sit or pull up in the hammock it is no longer suitable.**



With a Mattress Stiffener



Without a Mattress Stiffener

## Natures Sway Accessories

Available from  
[www.naturesway.co.nz](http://www.naturesway.co.nz)  
& our stockists



Olive Green Organics Hammock. Baby can be swaddled and tucked in with a sheet or blanket.

### Natures Sway Fitted & Top Sheets

All our sheets are 100% cotton. Options are; fluffy brushed cotton, homespun cotton for summer or our luxurious knit organic cotton.

### Natures Sway Cocofibre Mattress Stiffener

Designed to make your Natures Sway Baby Hammock firmer and flatter, this all natural product is made from coconut fibres held together with natural latex. Must be used underneath a mattress or mattress protector.



### Natures Sway Mosquito Net

Our specially designed mosquito net fits over the wooden beam of your Natures Sway Baby Hammock to keep baby safe from insects for an undisturbed sleep.

#### Also Available:

- Olive Green Organics Hammocks
- Organic Cotton Knit Swaddles
- Wool Mattress Protector
- Extra Long 1m Mattress
- Extra Long 1m Cocofibre Mattress Stiffener
- Scroll Spring Divider
- The *'Little Snuggles'* range of Swaddles and Muslin Cloths
- Cot and Bassinet Mattresses and Sheets made to order



**REPLACEMENT PARTS AVAILABLE**

## Natures Sway Travel Bag

A purpose built carry bag for your Natures Sway Baby Hammock and Stand. Made from strong natural canvas, with individual compartments for each piece of the stand to prevent scratching and rattling. Canvas flaps with velcro close each end, allowing the bag to be used to carry your other Natures Sway accessories as well. The ideal travel bed in a bag.



## Washing Instructions

### Sheets

Machine wash on a normal cycle. Can be tumble dried. Hot iron.

### Hammock

Take the opening D-ring off and wash with the stainless steel ring still attached and moving freely. Machine wash on normal cycle. Do not tumble dry. For best results: iron when wet (directly after final spin) and hang to dry with the ring at top centre. Once fabric is fully dry, ensure the hammock is centred and re-attach D-ring.

### Wool Mattress

Gentle surface wash only. If wool gets fully submerged it tends to compact and will be permanently altered, the warranty does not cover this. If you want to try, gently hand-wash, using wool detergent in lukewarm water (20°). Do not wring, gently roll in a towel to remove excess water. Lie flat to dry outside or in a warm cupboard. Do not tumble dry. Use a cool iron.

## Specifications

Samples of all the metal parts have been strength tested on a 58 tonne computerised testing bed calibrated by Australian Calibrating Services. All parts have a minimum working weight of 75kg and a breaking weight of no less than 200kg. All springs have been fitted with a secure length of nylon webbing allowing a maximum stretch of 30cm. The recommended maximum safe weight is 15kg which is equivalent to the average 2 year old (according to the NZ Department of Health growth chart).

## Natures Sway Solutions Range

The Natures Sway Organics Solutions Range is comprised of three soft-structure baby carriers, designed to make carrying your baby enjoyable and promote bonding through closeness.

Available from  
[www.naturesway.co.nz](http://www.naturesway.co.nz)  
& our stockists



### Baby & Toddler Sling

Baby safely by your side in a comfortable and supported position. Once baby can sit up, use as a hip seat until three years.



### Pouch Pack

Reclaim your freedom and get mobile with an ergonomic design. Can be worn on the front, back or side. From newborn to three years.



### Carry Wrap

A content and satisfied baby without tricky props or gadgets. Comfortable as a second skin. Best for small babies.

### Worldwide Distributors:

Natures Sway  
180C McLeod Rd, Henderson  
Auckland 0610, New Zealand  
Tel +64 9 838 2374  
[info@naturesway.co.nz](mailto:info@naturesway.co.nz)  
[www.naturesway.co.nz](http://www.naturesway.co.nz)

### Japan:

Tel +81 76 245 6660  
[www.rua-kids.com](http://www.rua-kids.com)

### European Union, Norway & Iceland

Tel +45 4045 6347  
[www.sneglehuset.com](http://www.sneglehuset.com)



### 2 Year Warranty

Conditions apply.

**Warranty:** Natures Sway Baby Hammocks are manufactured to the highest standards to ensure the comfort and safety of your baby. All products (except mattress) carry a 2 year manufacturer's replacement guarantee. Natures Sway will guarantee the mattress against manufacturing faults for 6 months. The mattress will naturally compact with use and requires special washing procedures. It is recommend that a new mattress be used for each new baby. Retain your sales receipt and record your date and place of purchase here:

For warranty enquiries contact your national distributor or Natures Sway directly.

**Disclaimer:** The warranty is subject to proper installation and user must complete all the requirements on the Safety Checklist before use. The warranty will be void if the instructions are not followed or products are subjected to abuse, negligence, improper use, inappropriate adaptation, or the hammock is attached to equipment other than that manufactured or approved by Natures Sway.